

Bachelor Thesis

RF Level Adjustment for 7-Tesla Magnetic Resonance Tomograph (MRT) Vector Modulator

Prepared by

Muhammad Kashif Aqil

DS0075132201

Supervised by

Prof. Dr.-Ing. K. Solbach

Universität Duisburg-Essen
Department of RF-Technology

Duisburg, 04-September-2009

- Problem Introduction
- Aim of the Thesis
- Design Details
- Simulation and Test Results
- Conclusion

Why we are interested in designing Attenuator circuit in MRT Vector Modulator?

- To reduce the amplitude or power of a signal
- To adjust the input level of the Vector Modulator
- To attenuates the output signal with adjustable attenuation

To design a printed circuit for the Attenuator circuit, using commercial ICs and other surface-mount technology (SMD) components at 300 MHz in order to compensate the inhomogeneous field distributions inside the Patient's body.

Attenuators

- To reduce the amplitude or power of a signal without appreciable distortion of its waveform.

Types of Attenuators

- Pi Attenuator
- T Attenuator
- Bridged T Attenuator

Characteristics of RF Attenuators

- Accuracy of realized attenuation
- Low standing wave ratio
- Flat frequency response
- Repeatability of attenuation

Attenuators

Voltage Control Attenuator MVA-2000+

Advantages are

- Absolute Max. Supply Voltage (V^+) range in between +3V to +5V
- Absolute Max. Control Voltage ($V_{control}$) range is between +0V to +12V.
- Broadband, 10-2000 MHz
- Low Insertion Loss, 1.9dB Type.
- Small phase deviation over attenuation range
- No RF matching network required
- Low cost of production



Attenuators

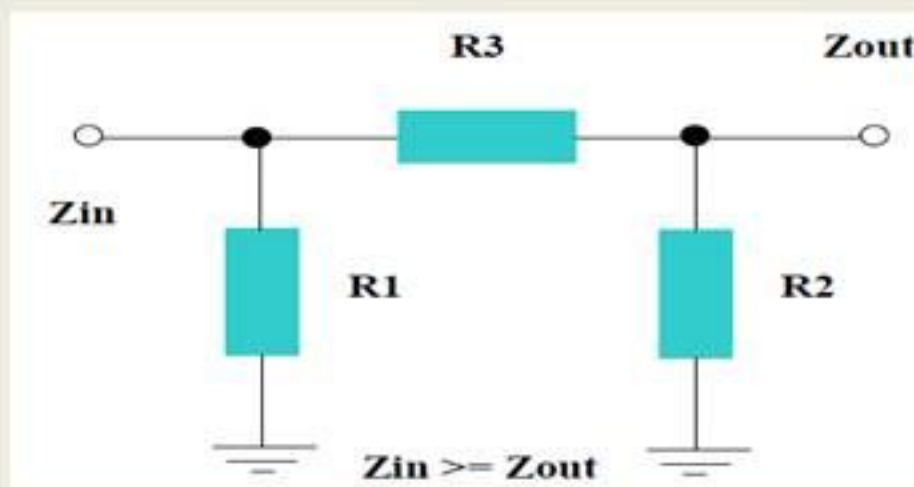

Pi Attenuator

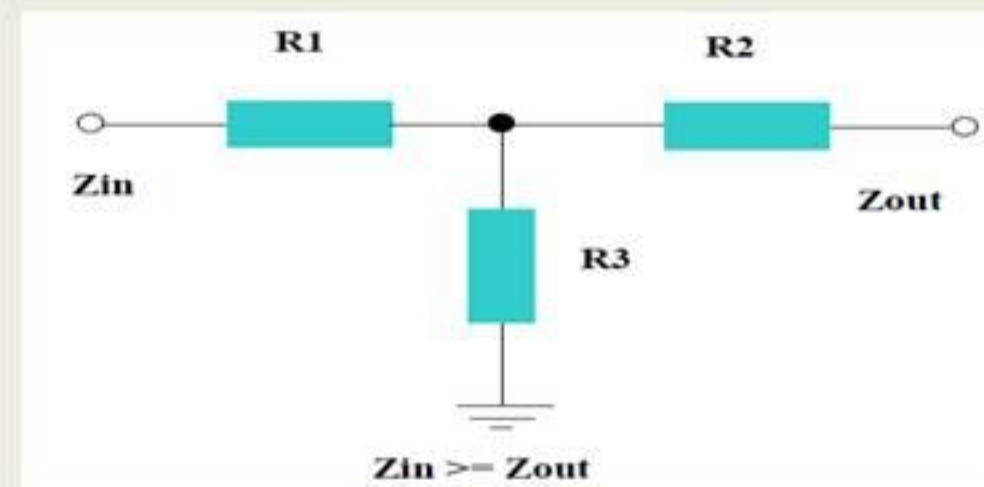

Tee Attenuator

Attenuators

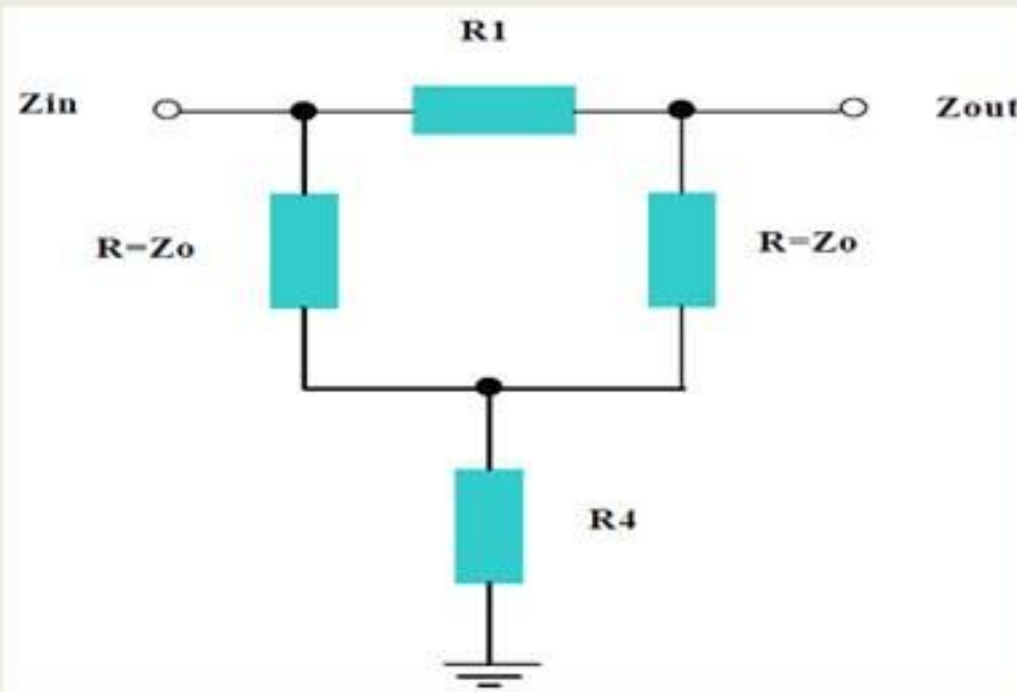

Bridged T attenuator

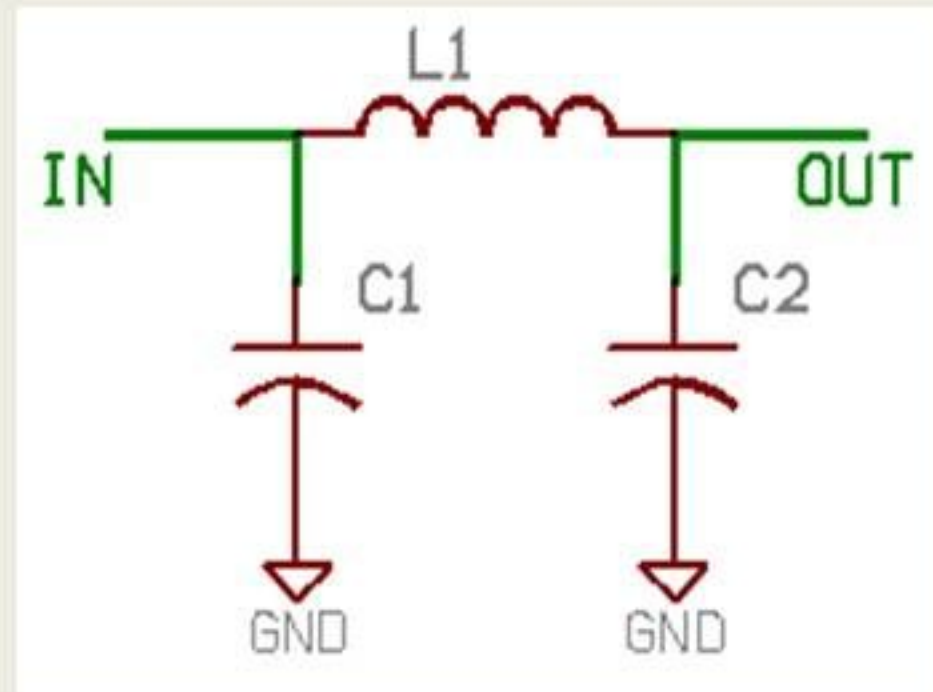

Butterworth pi network low pass filter

Voltage Control Attenuator

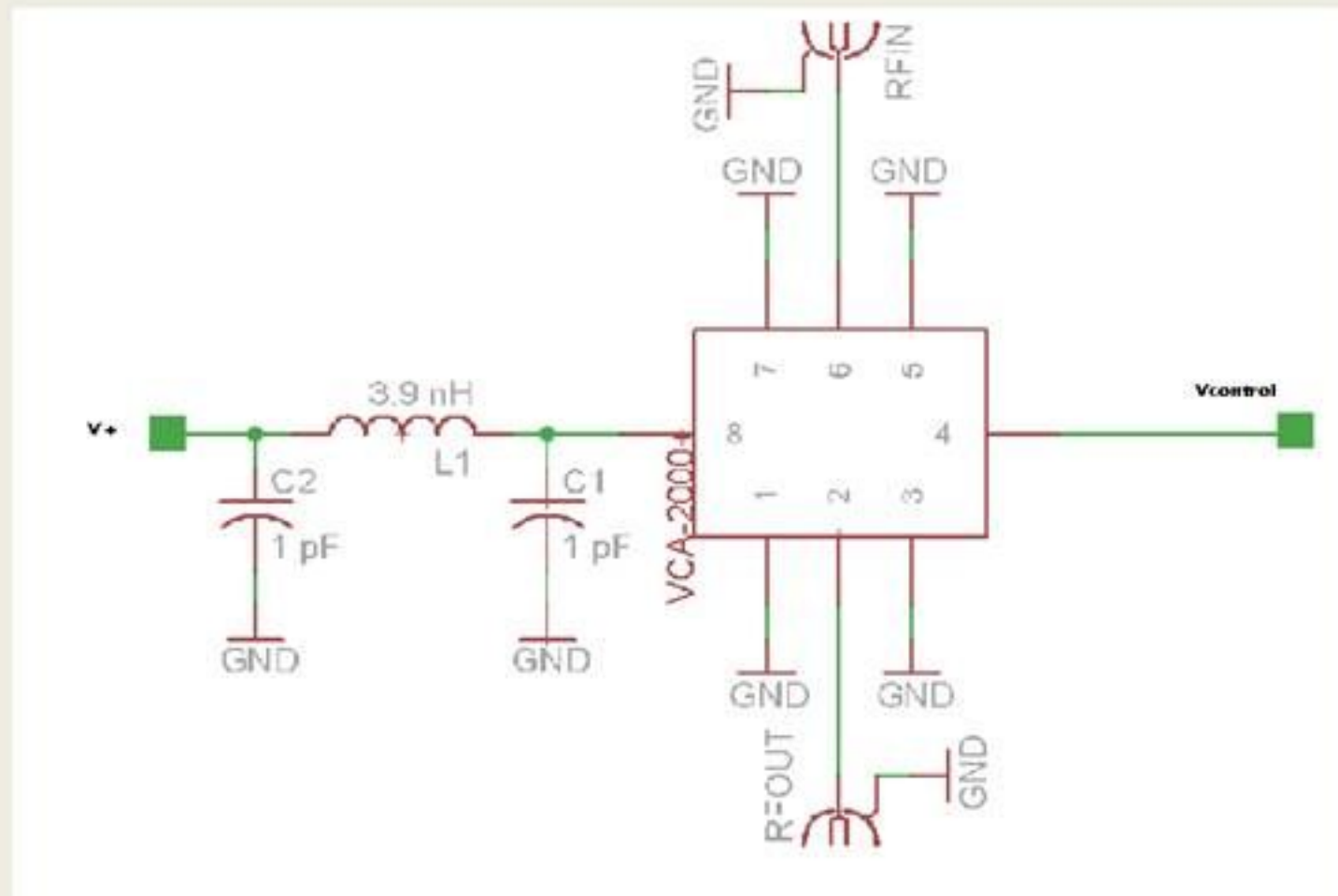

schematic diagram

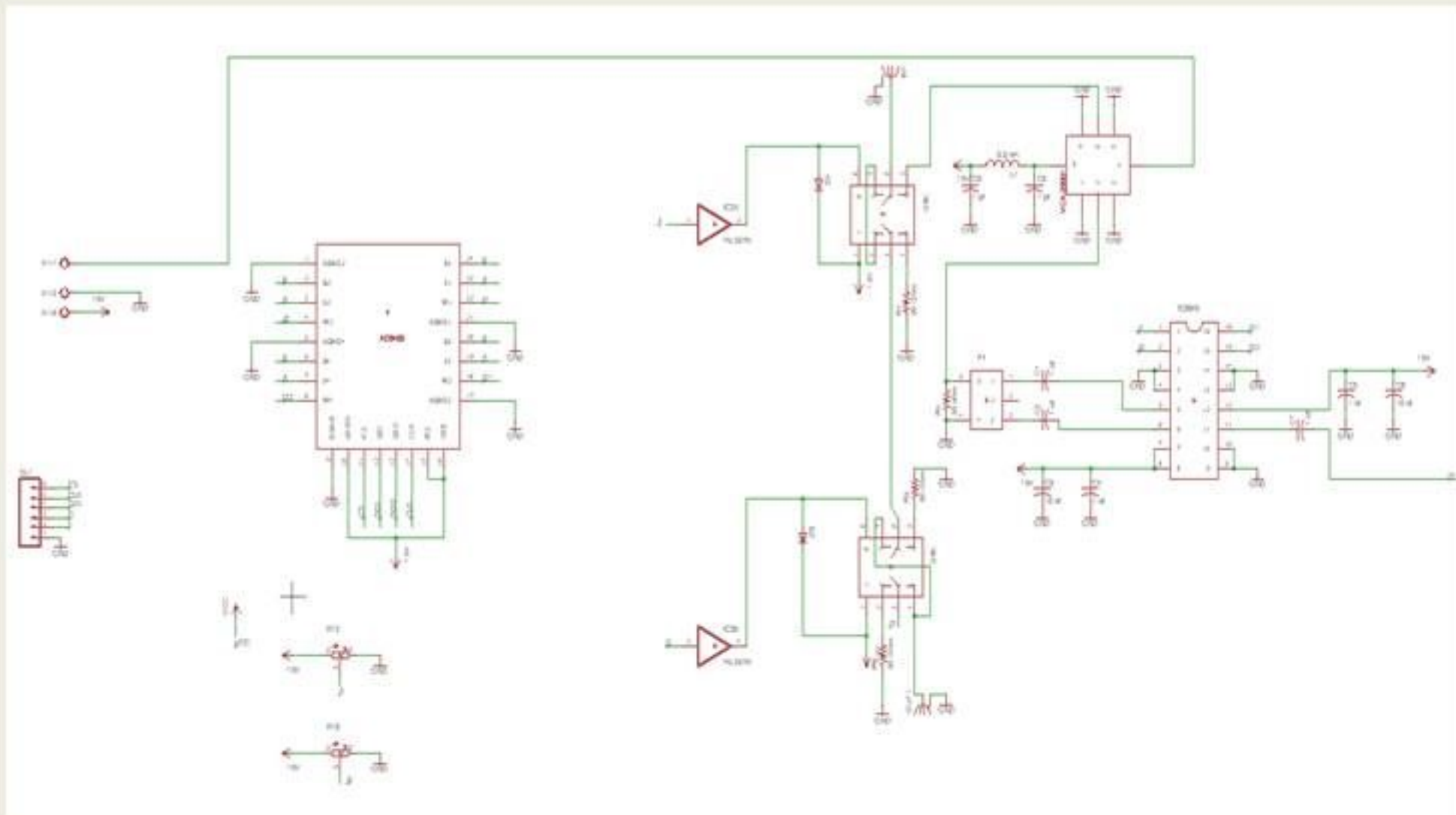

The Vector Modulator standard schematic diagram with integrated Voltage Control Attenuator (VCA)

Attenuator and SMD components

MVA-2000+



SMD 0805 Epcos 1 pF Capacitors



Voltage Variable Attenuator

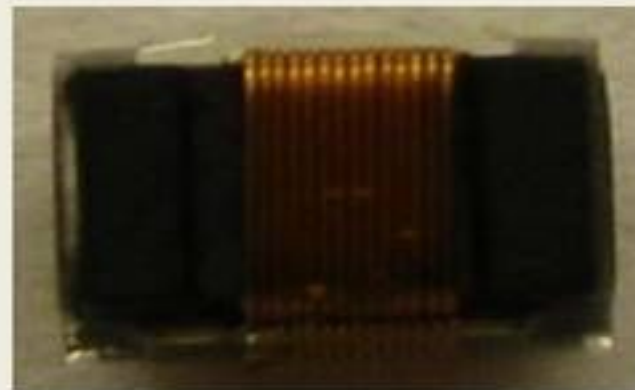

SMD 0603 Kemet 3.9 nH inductors

Printed Circuit Test Board

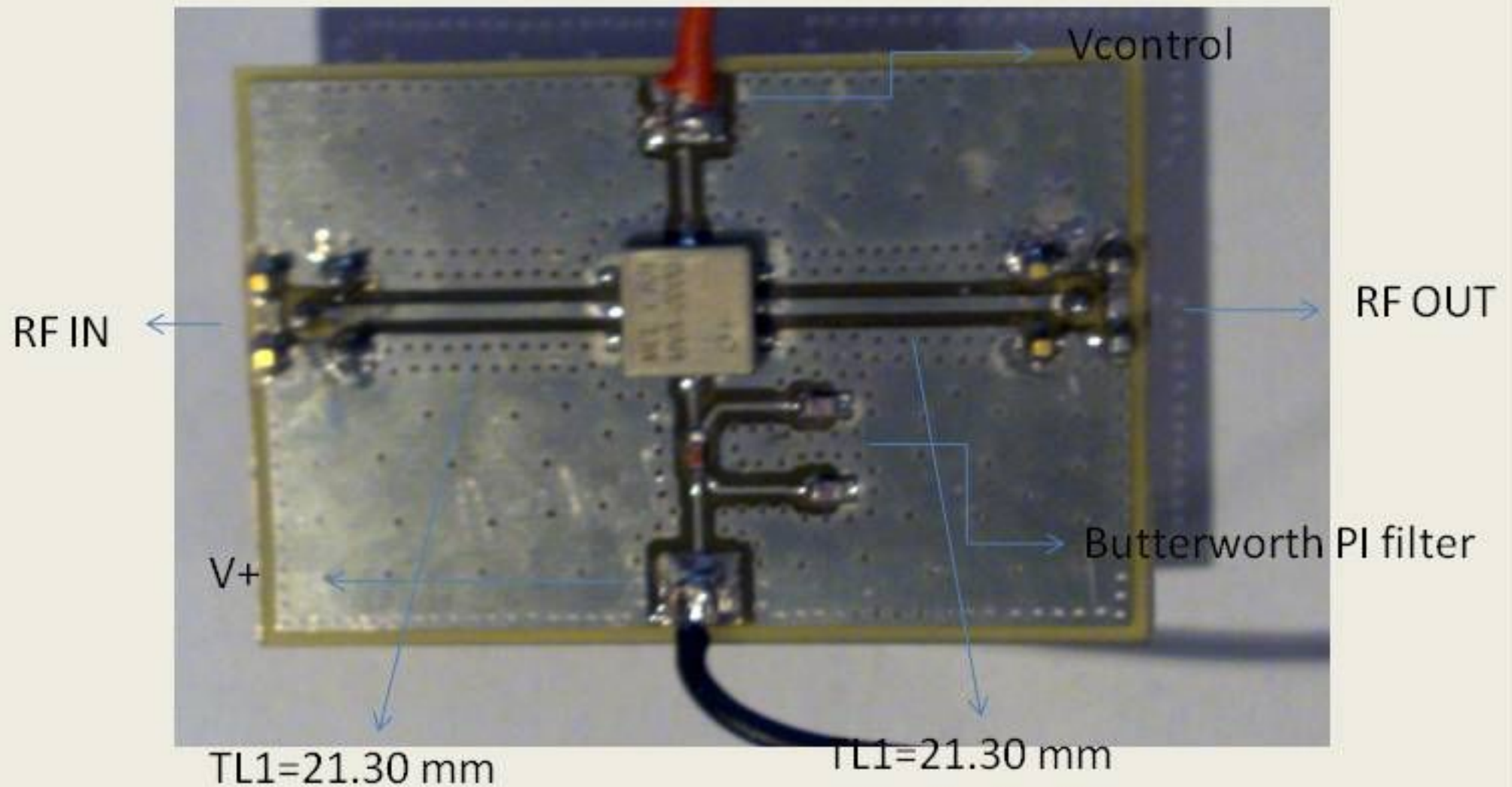

An assembled PCB of Voltage Control Attenuator

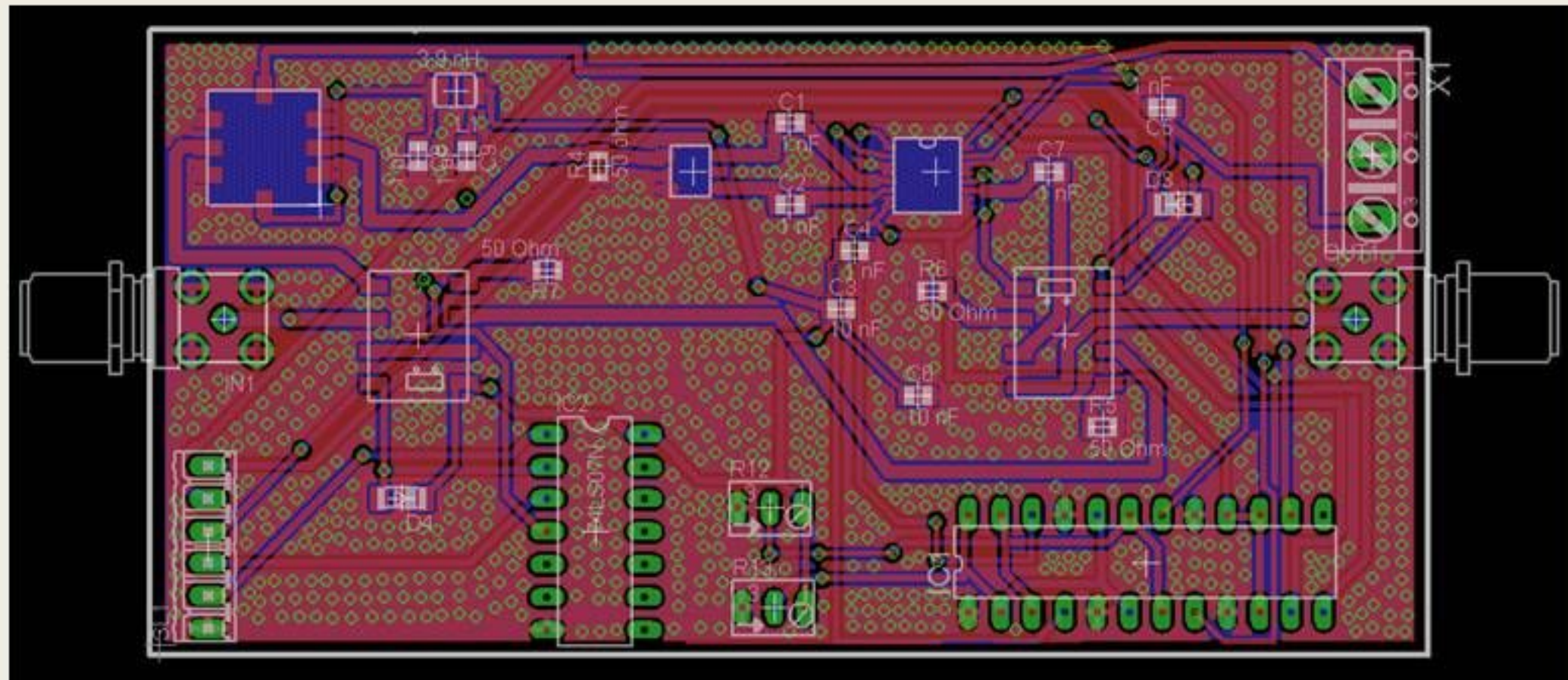

The Vector Modulator layout with integrated Voltage Control Attenuator (VCA)

Attenuation

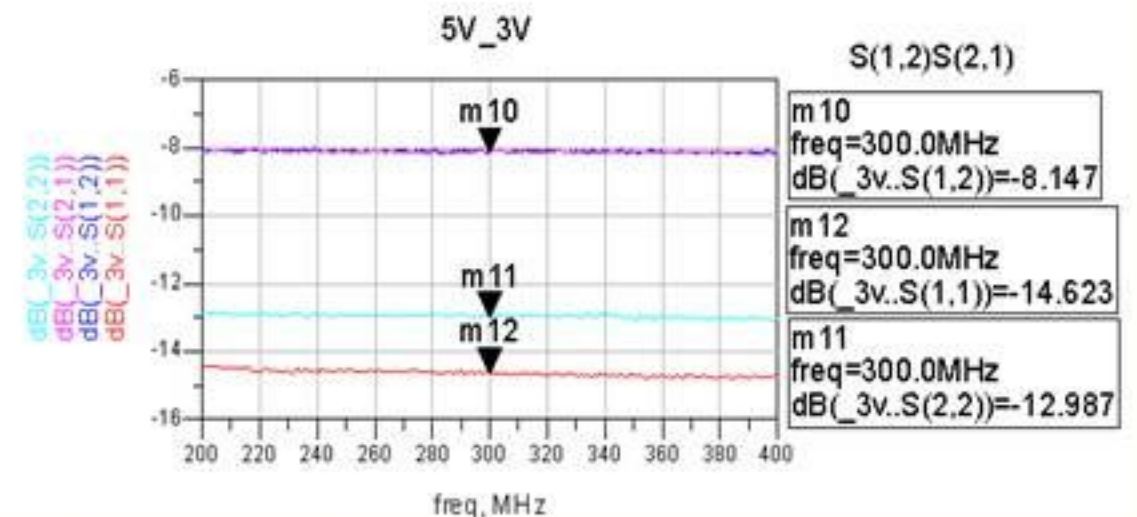
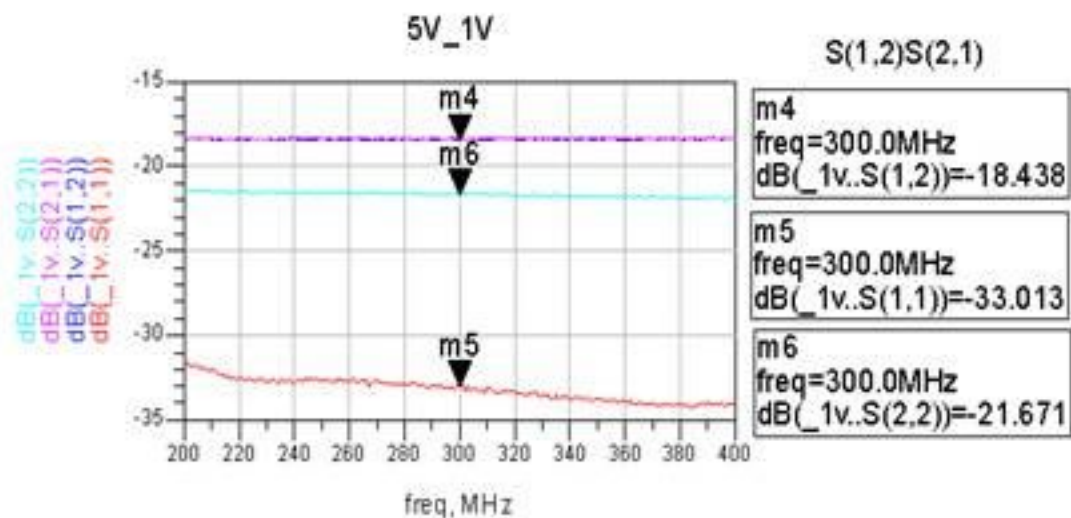
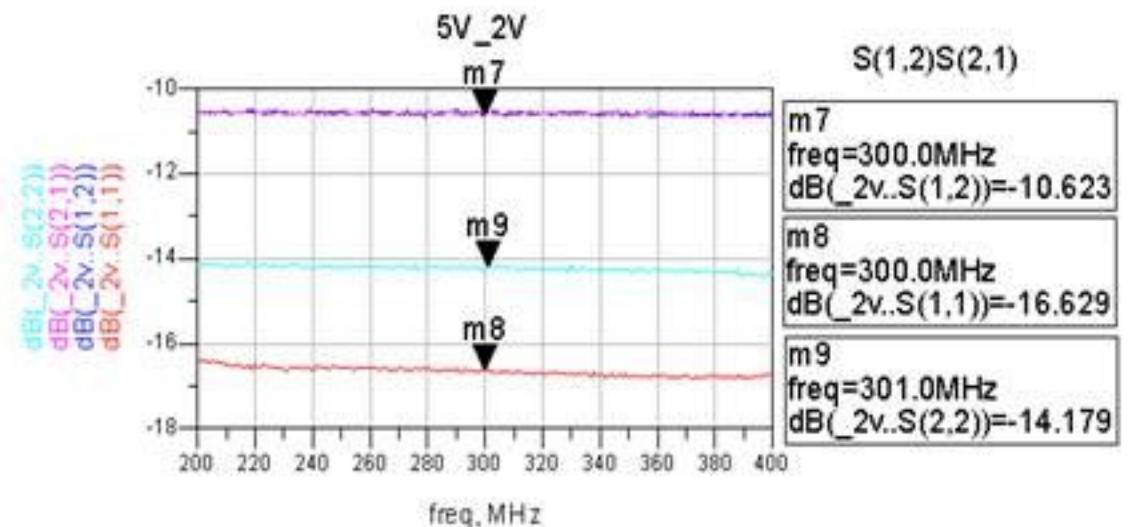
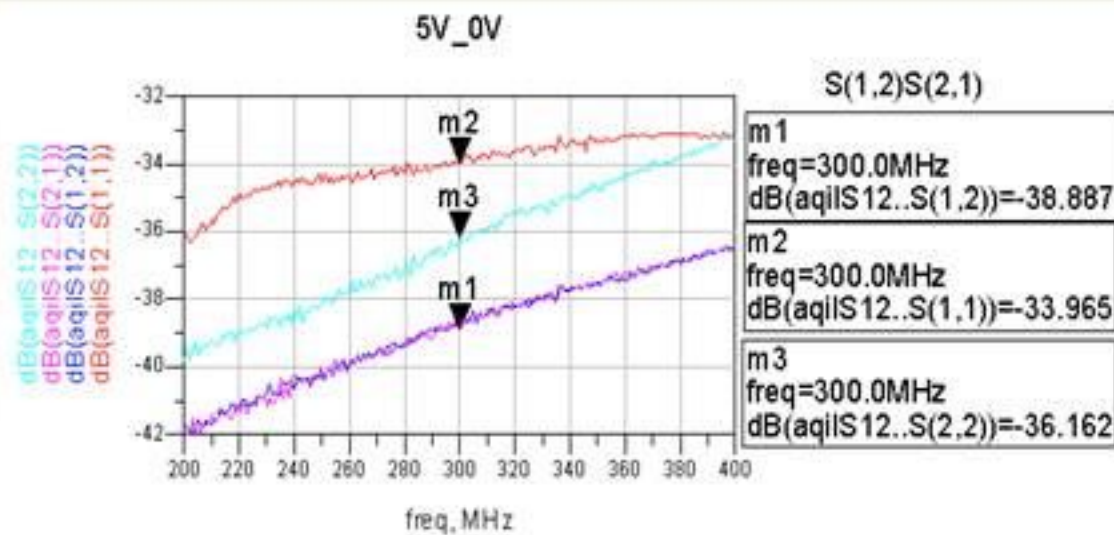

Comparison of 1 stage of the forward, reverse reflection coefficients and transmission coefficients with Vcontrol from +0V to +3V and Supply Voltage +5V

Attenuation

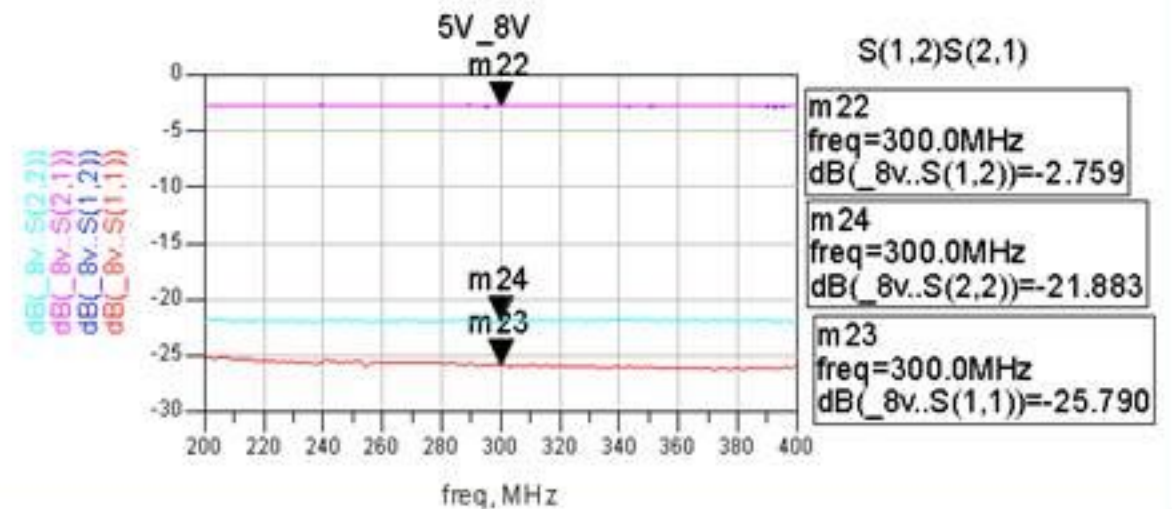
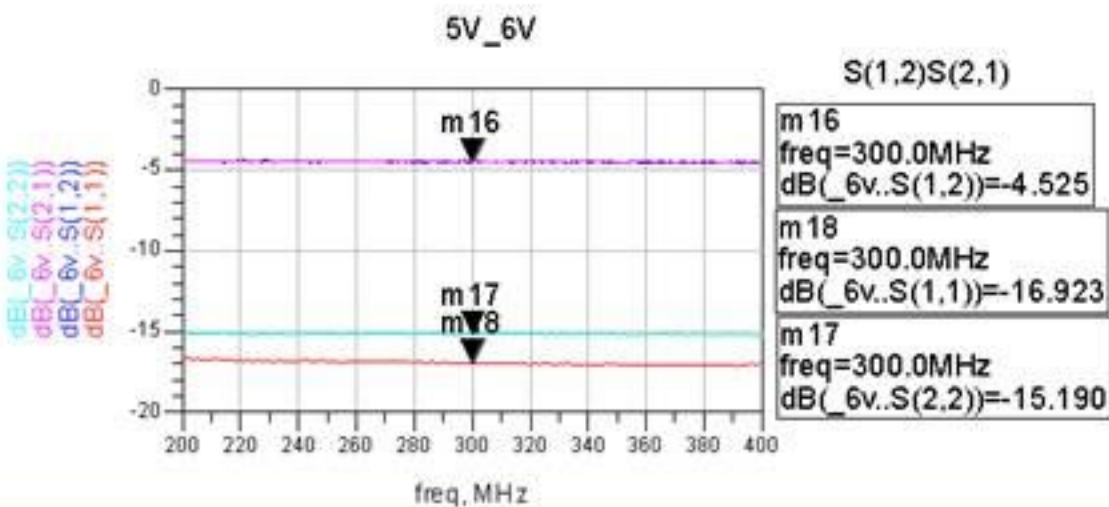
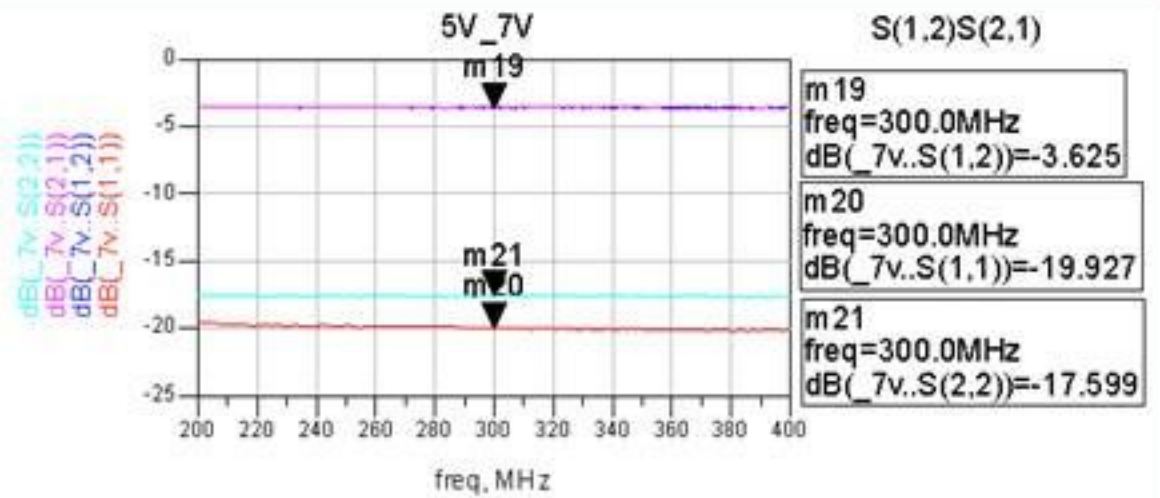
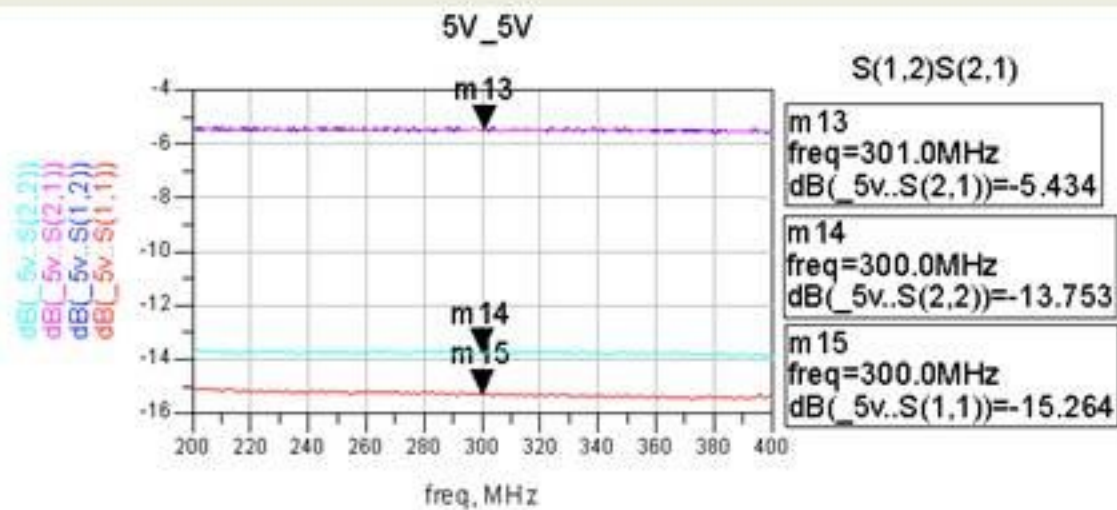

Comparison of 1 stage of the forward, reverse reflection coefficients and transmission coefficients with Vcontrol from +5V to +8V and Supply Voltage +5V

Attenuation

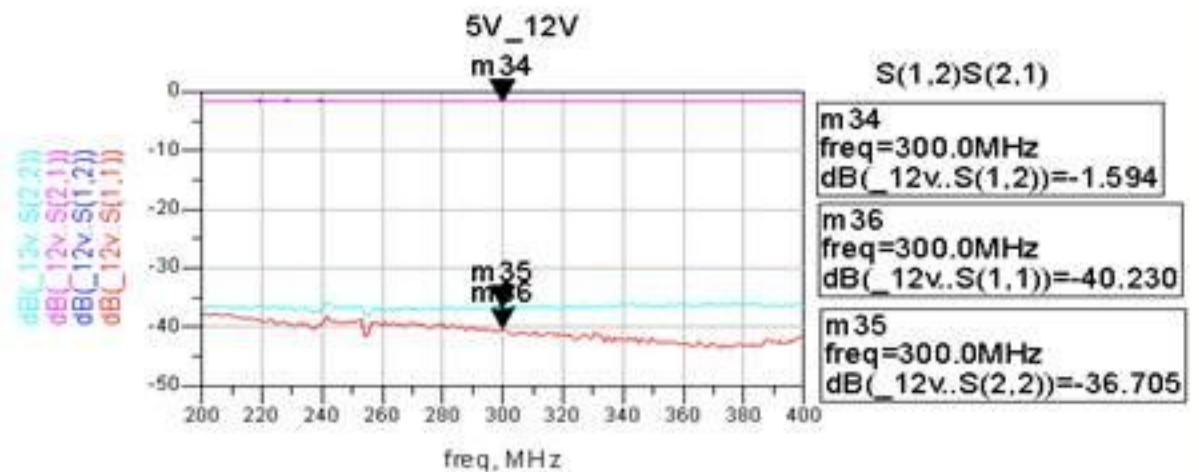
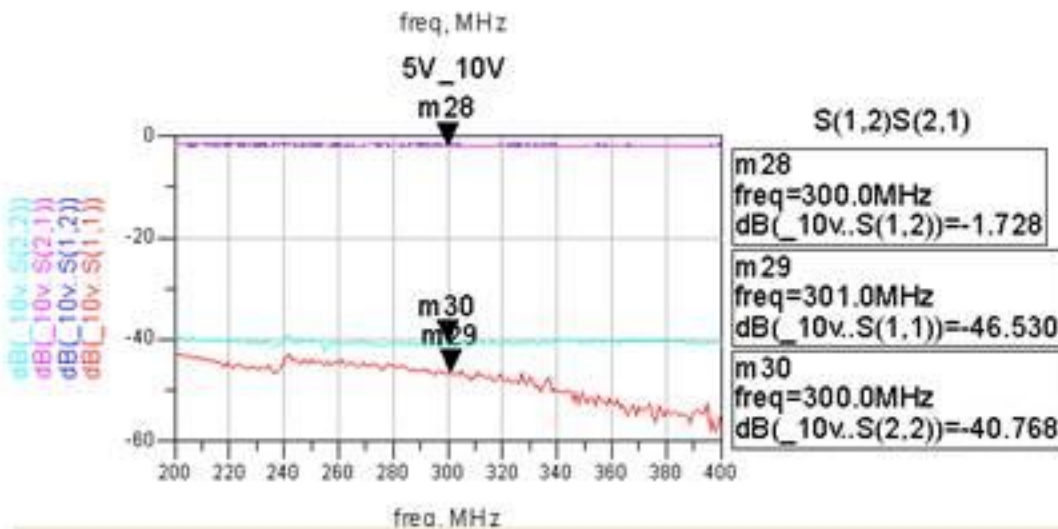
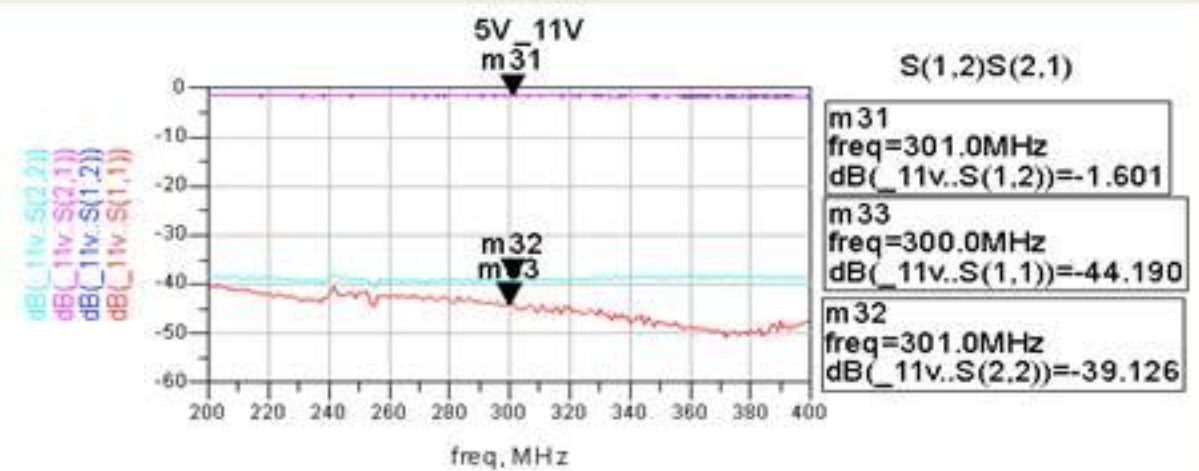
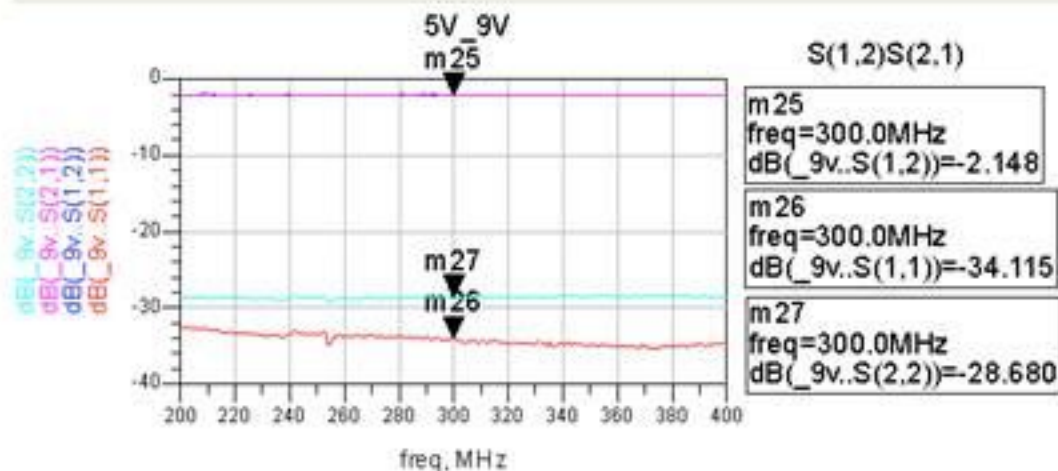

Comparison of 1 stages of the forward, reverse reflection coefficients and transmission coefficients with Vcontrol from +9V to +12V and Supply Voltage +5V

Comparison with the data sheet

MVA-2000+
ATTENUATION Vs. FREQUENCY
OVER CONTROL VOLTAGES @ V+=3V

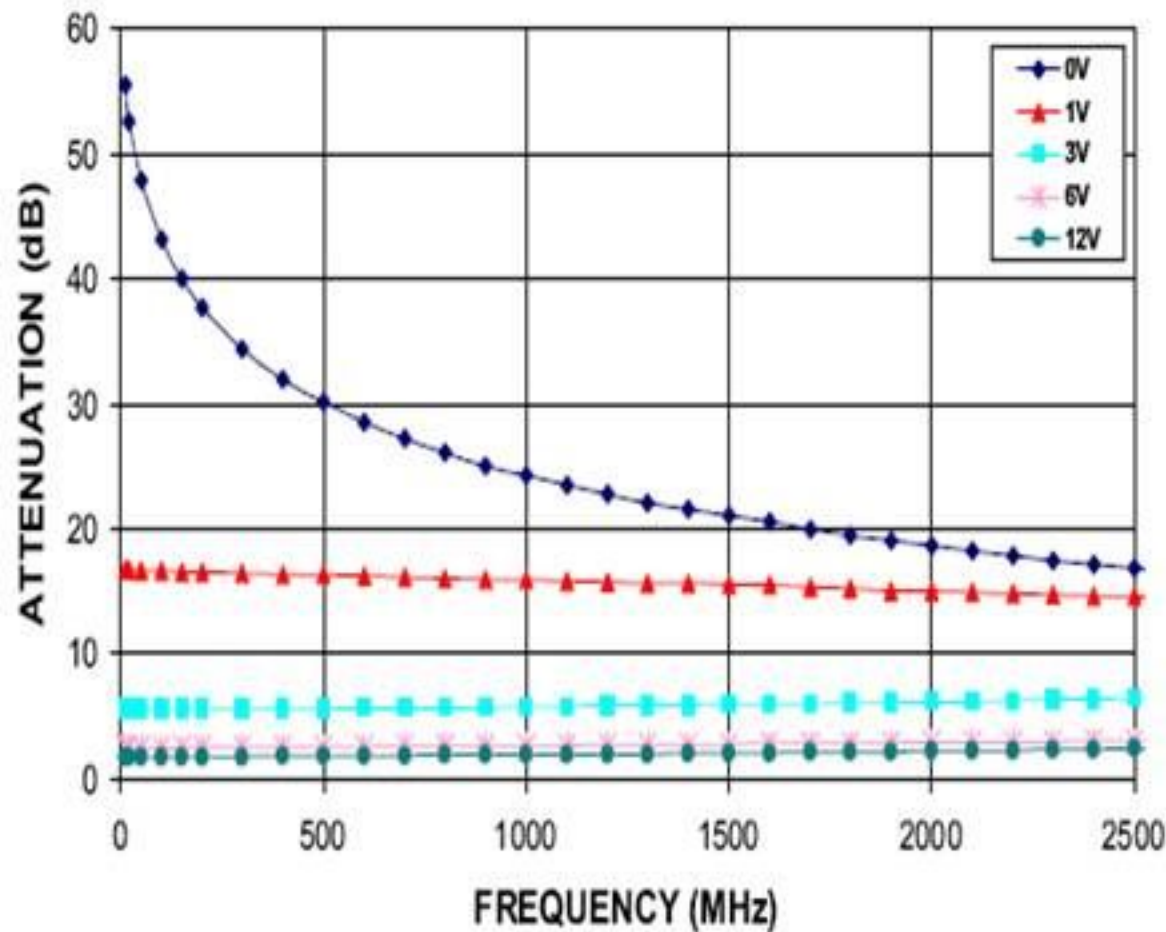

MVA-2000+
ATTENUATION Vs. FREQUENCY
OVER CONTROL VOLTAGES @ V+=5V

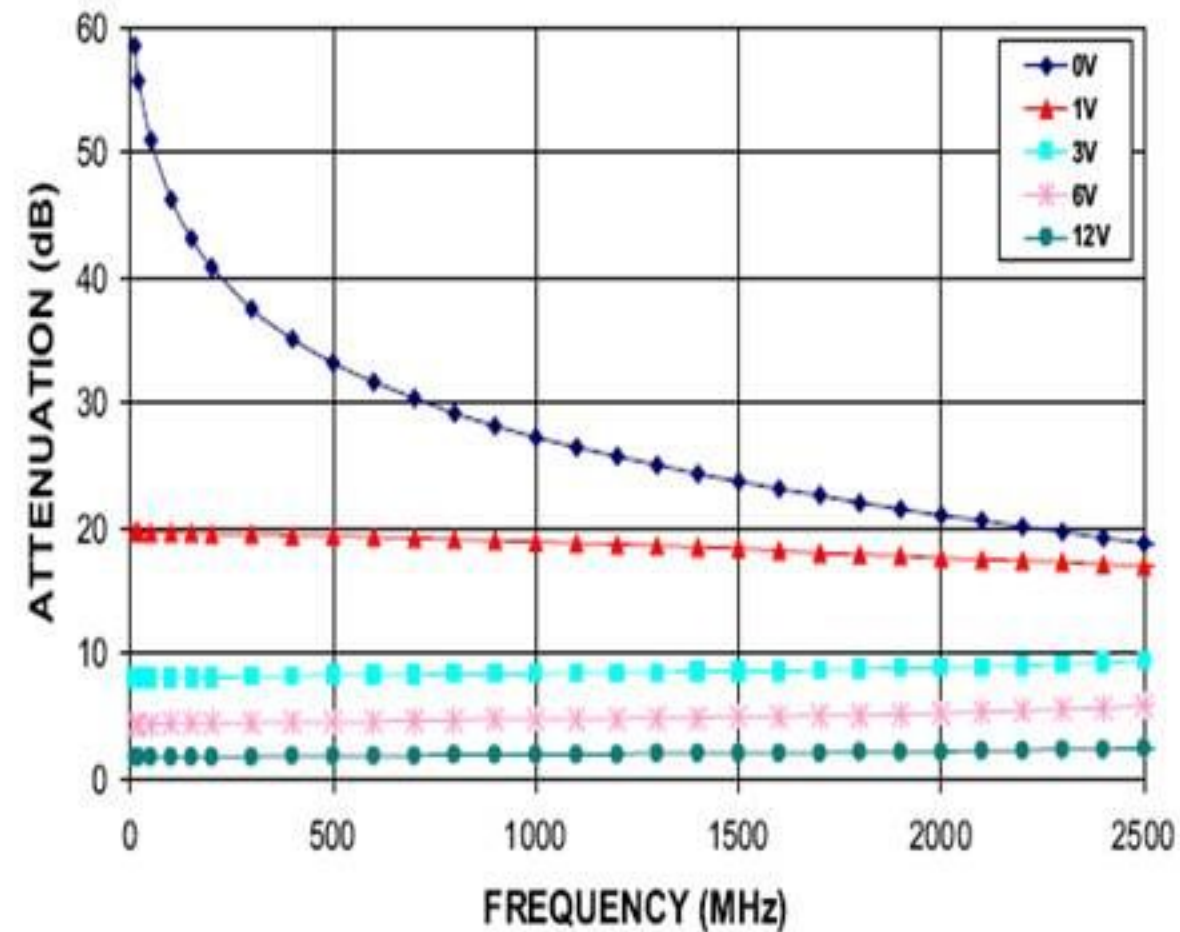

Attenuation

Voltage Control V+	Attenuation (dB)			
	s11	s12	s21	s22
0-12V				
0V	-33.965	-38.887	-38.887	-36.162
1V	-33.013	-18.438	-18.438	-21.671
2V	-16.629	-10.623	-10.623	-14.179
3V	-14.623	-8.147	-8.147	-12.987
4V	-14.124	-6.281	-6.281	-13.312
5V	-15.264	-5.434	-5.434	-13.753
6V	-16.923	-4.525	-4.525	-15.190
7V	-19.927	-3.625	-3.625	-17.599
8V	-25.790	-2.759	-2.759	-21.883
9V	-34.115	-2.148	-2.148	-28.680
10V	-46.530	-1.728	-1.728	-40.768
11V	-44.190	-1.601	-1.601	-39.126
12V	-40.230	-1.594	-1.594	-36.705

The Attenuator PCB results by using network analyzer

Comparison S12 and S21 with the data sheet MVA 2000+

FREQ. (MHz)	ATTENUATION Vs. V CONTROL Vs. V+									
	(dB)									
	@V Control=0V		@V Control=1V		@V Control=3V		@V Control=6V		@V Control=12V	
	@V+=3V	@V+=5V	@V+=3V	@V+=5V	@V+=3V	@V+=5V	@V+=3V	@V+=5V	@V+=3V	@V+=5V
10	55.55	58.51	16.78	19.71	5.57	8.03	2.51	4.33	1.73	1.72
20	52.61	55.69	16.70	19.66	5.55	8.04	2.49	4.33	1.71	1.71
50	47.86	50.94	16.62	19.63	5.54	8.08	2.49	4.35	1.72	1.71
100	43.17	46.23	16.59	19.58	5.54	8.07	2.47	4.38	1.71	1.71
150	40.01	43.10	16.51	19.56	5.51	8.09	2.48	4.39	1.72	1.71
200	37.72	40.76	16.52	19.54	5.54	8.09	2.49	4.39	1.73	1.73
300	34.39	37.49	16.45	19.49	5.55	8.12	2.51	4.43	1.74	1.73
400	31.97	35.07	16.38	19.43	5.58	8.18	2.53	4.48	1.77	1.77

PHASE

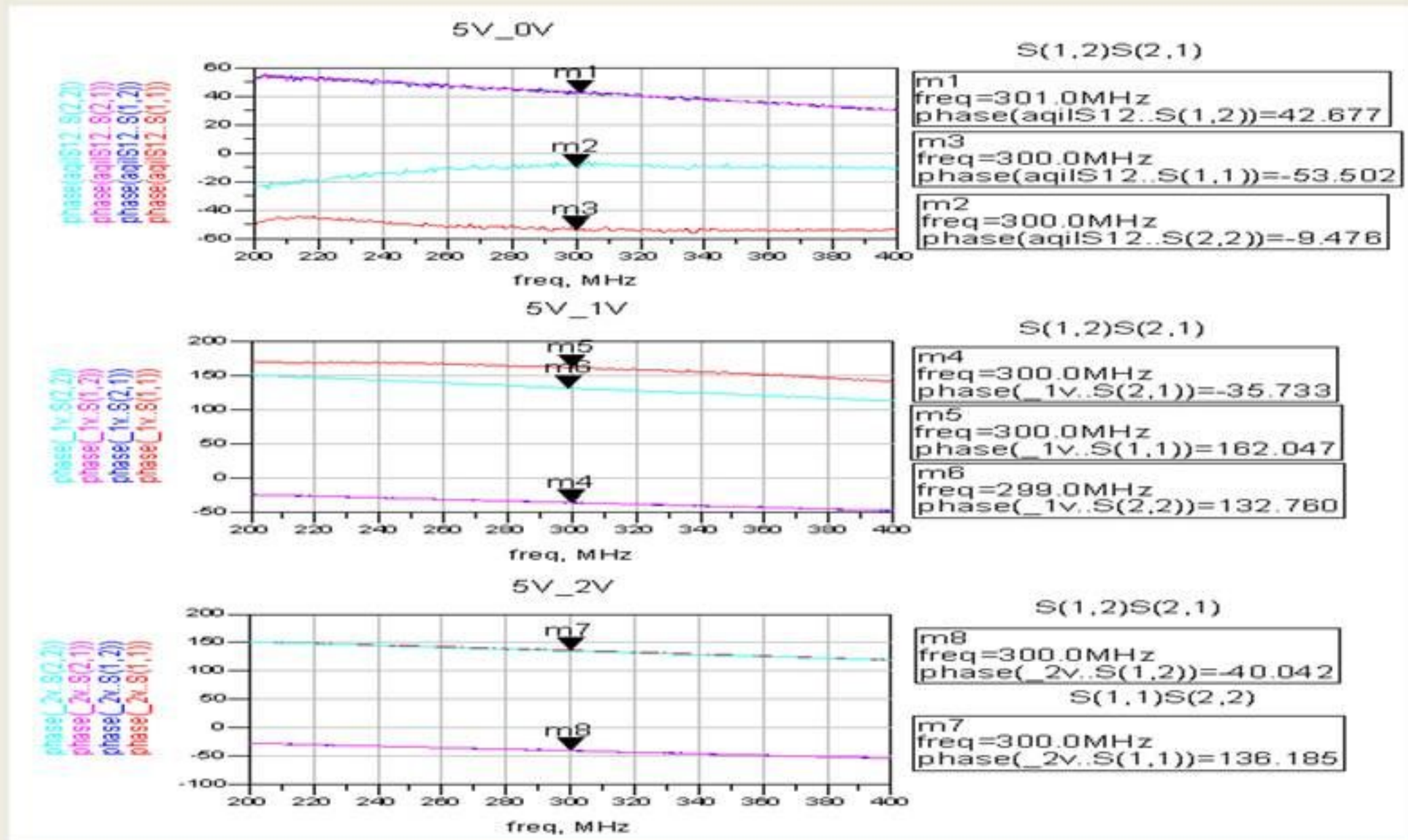

Comparison of 1 stages of the forward, reverse reflection coefficients and transmission coefficients with Vcontrol from +0V to +2V and Supply Voltage +5V

Phase

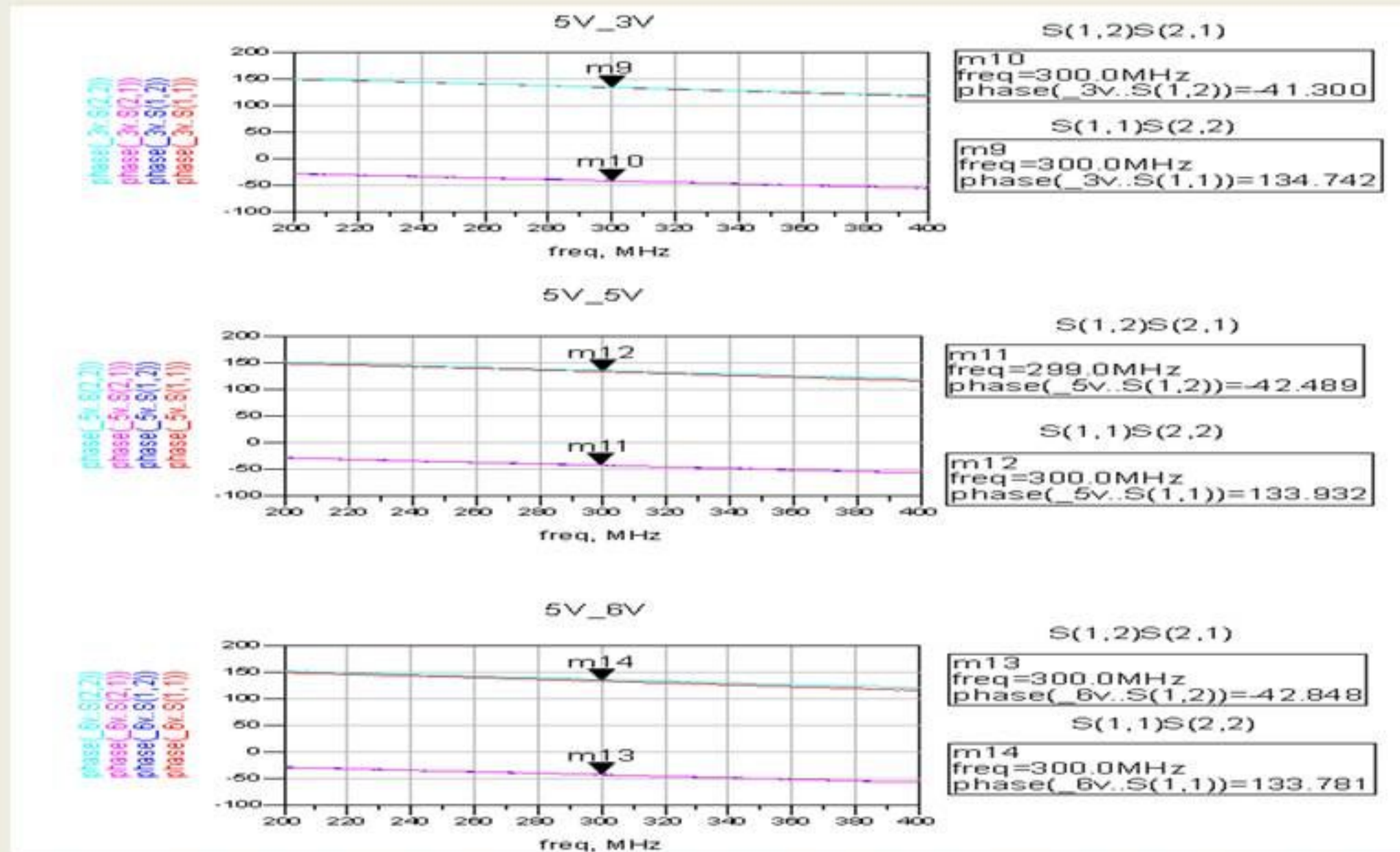

Comparison of 1 stages of the forward, reverse reflection coefficients and transmission coefficients with Vcontrol from +3V to +6V and Supply Voltage +5V

Phase

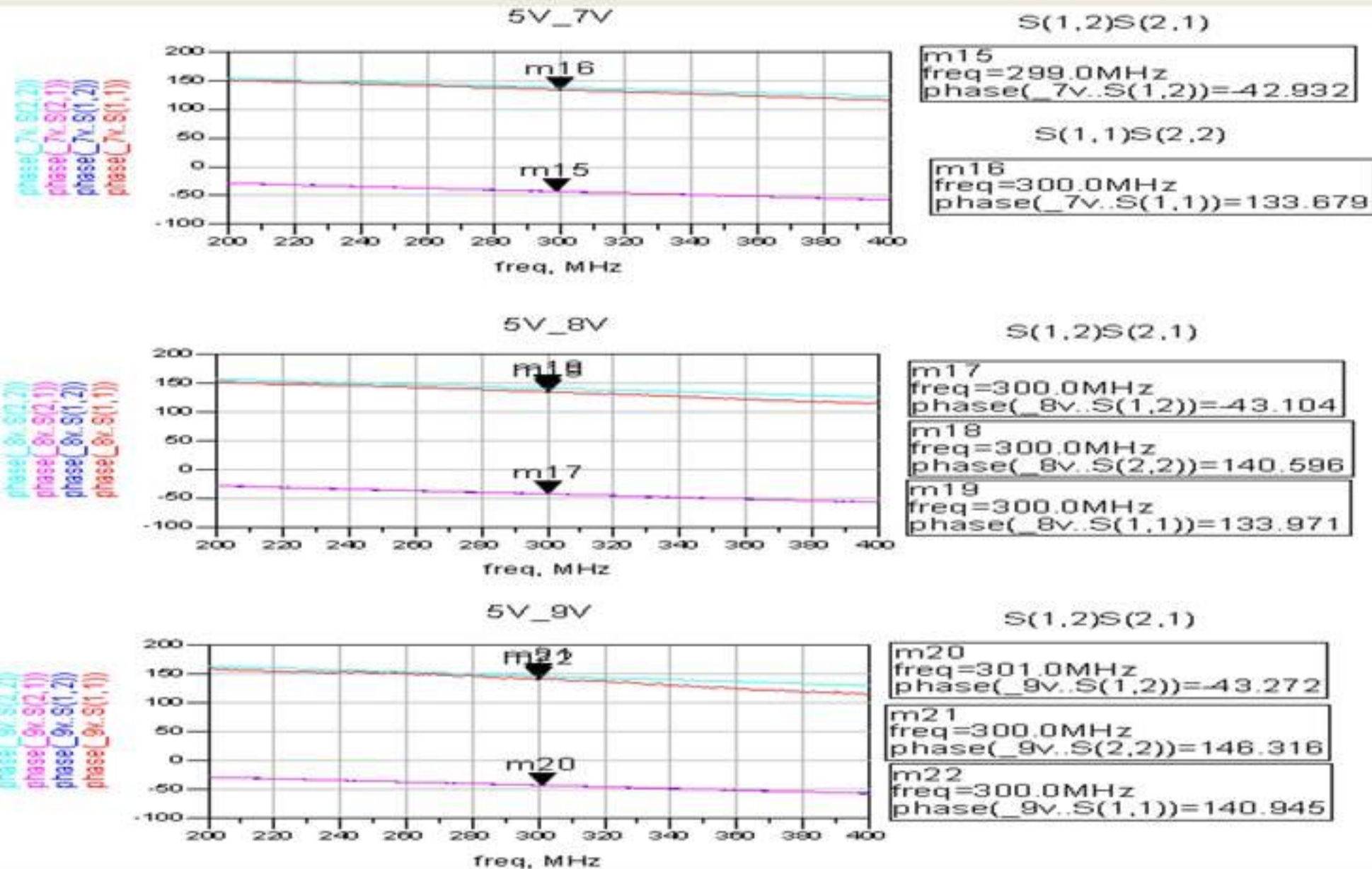

Comparison of 1 stages of the forward, reverse reflection coefficients and transmission coefficients with Vcontrol from +7V to +9V and Supply Voltage +5V

Phase

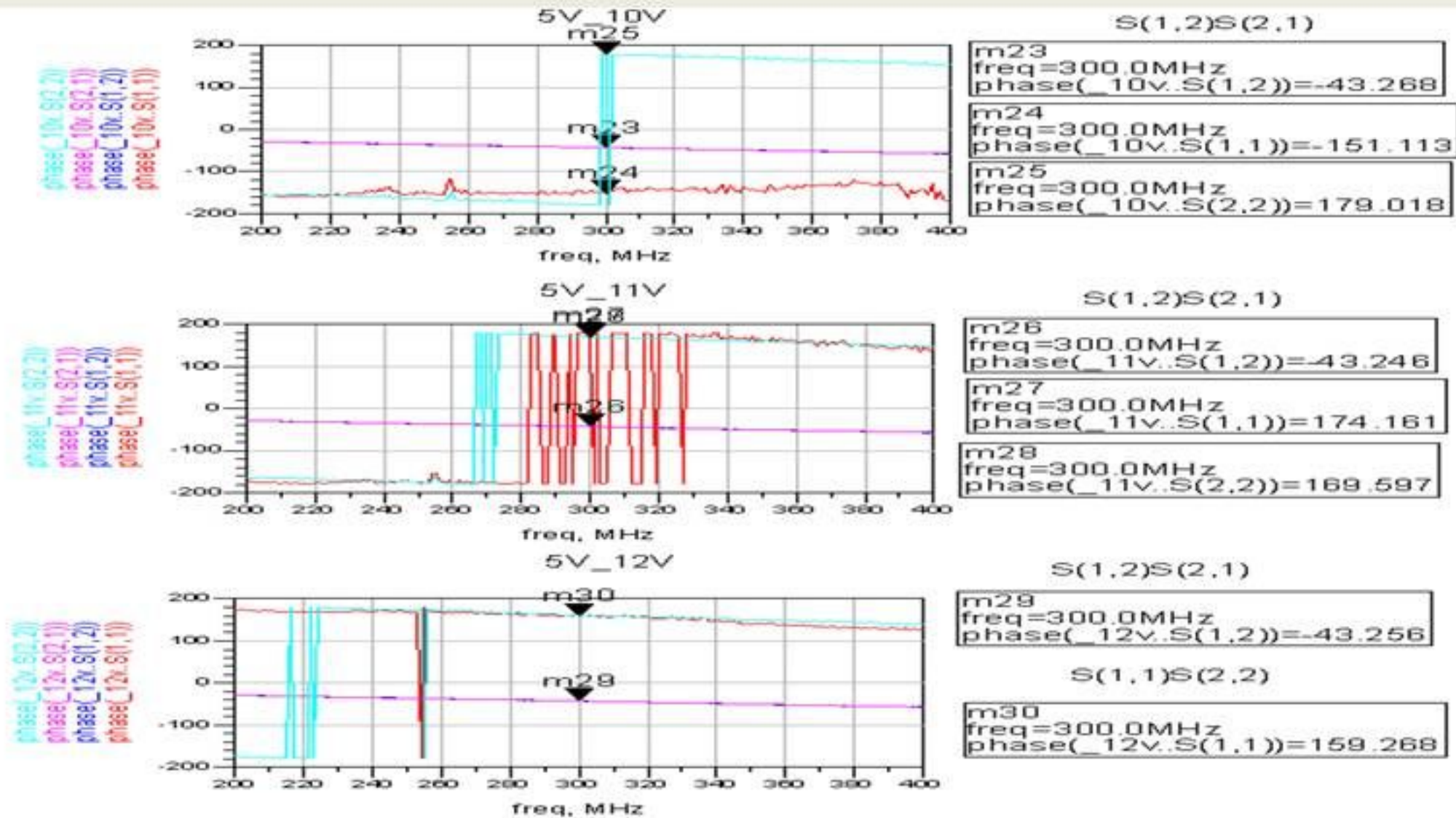

Comparison of 1 stages of the forward, reverse reflection coefficients and transmission coefficients with Vcontrol from +10V to +12V and Supply Voltage +5V

Phase

Voltage Control V+	Phase (degree)			
	s11	s12	s21	s22
0-12V				
0V	-53.502	42.677	42.677	-9.476
1V	162.047	-35.733	-35.733	132.760
2V	136.185	-40.042	-40.042	136.185
3V	134.742	-41.300	-41.300	134.742
4V	134.342	-41.890	-41.890	134.293
5V	133.932	-42.489	-42.489	133.932
6V	133.781	-42.484	-42.484	133.781
7V	133.679	-42.932	-42.932	133.679
8V	133.971	-43.104	-43.104	140.596
9V	140.945	-43.272	-43.272	146.316
10V	-151.11	-43.268	-43.268	179.018
11V	174.161	-43.246	-43.246	169.597
12V	159.268	-43.256	-43.256	159.268

The Attenuator PCB results by using network analyzer

Comparison with the data sheet MVA 2000+

FREQ. (MHz)	PHASE SHIFT Vs. V CONTROL Vs. V+									
	(deg)									
	@V Control=0V		@V Control=1V		@V Control=3V		@V Control=6V		@V Control=12V	
	@V+=3V	@V+=5V	@V+=3V	@V+=5V	@V+=3V	@V+=5V	@V+=3V	@V+=5V	@V+=3V	@V+=5V
10	126.64	128.23	178.45	179.07	179.16	179.48	179.06	179.30	178.98	179.04
20	127.53	129.13	180.23	180.74	181.31	181.55	181.32	181.60	181.36	181.28
50	120.70	120.04	183.74	183.90	185.46	185.63	185.56	185.87	185.65	185.62
100	117.61	117.56	189.12	188.93	191.75	191.80	192.01	192.15	192.12	192.12
150	119.68	118.78	194.07	193.58	197.86	197.75	198.14	198.30	198.32	198.28
200	123.13	122.28	199.07	198.28	203.95	203.72	204.31	204.44	204.53	204.51
300	132.51	130.91	209.07	207.81	215.97	215.58	216.49	216.55	216.78	216.78
400	143.12	140.57	219.14	217.10	228.02	227.39	228.63	228.70	228.98	229.00

Specifications of the Attenuator

- Insertion loss < 0.5 db
- Phase has the same difference as compared to datesheet

Significant differences in (S_{11}) and phase (S_{21})

- For phase of S_{21} is the line length are the crucial matters but regardless the size of the phase variation to compare. Both values fit well together.
- S_{11} has variations but the worst value of the measurement (about -14 dB) fits well with the datesheet value of -16 dB (however, at another V_{control}) because its varies with the different Voltage control
- its crucial for the application but it has to be developed further for different V_{control} for its optimize usage in future application

Thank You For Your Kind Attention!